



The BEULAHTIN

Mission & Ministry in Progress

The BEULAHTIN
September 2010



SUNDAY, SEPTEMBER 12

“Grow Your Faith - Deep and Wide”

Join your Beulah members and friends for the kickoff of a new Sunday School Year for all ages!

- 9:00 a.m. Pancake Breakfast in the Ramsey Building Gym for everyone!
- 9:00 a.m. A RALLY DAY FAIR - Something new!
The fair will take place at the same time as the Pancake Breakfast. The purpose of the fair is to make members and friends aware of all the opportunities available here at Beulah. Displays and a representative will be present to provide information and to answer questions about these various groups and activities here at Beulah Church. Each of the four commissions will also be represented.
- 9:30 a.m. Children and youth will be introduced to their teachers and will move to their new classes. Adults will stay in the Fireside Room to learn more about their classes.
- 10:40 a.m. Worship - Teachers will be introduced to the congregation and commissioned.

Inside this issue:

<i>Pastor's Letter</i>	2
<i>CE Information</i>	3/4/5
<i>Music & PW</i>	6/7
<i>Craft & Yard Sale Seminarian</i>	8/9
<i>Hunger Awareness Pumpkin Patch</i>	10/11
<i>Cedar Ridge Family Album</i>	12/13
<i>Birthdays Life Line Screening</i>	14/15



Sunday, September 26
12:00 p.m.
Ramsey Gym
Come Celebrate!

Homecoming Dinner, September 26! Join your Beulah friends in the Ramsey Gym, immediately following morning worship for a wonderful dinner and celebration in honor of Beulah's 142nd Anniversary!

The meat, drinks and desserts will be furnished by the Fellowship & Membership Commission. Please bring your best **homemade** dish, enough to feed 12 people. It is suggested that people with the last initial A-L bring salads or rolls and M-Z bring vegetable or meat dishes.

If you can help with setting up tables, chairs and decorations, please come to the Ramsey Gym on Saturday, September 25, at 10:00 a.m.



From the Pastor's Study

Dear Beulah Church Family,

September 2010

In the Book of Acts, chapter 17, the Apostle Paul is preaching before a group of people in the Greek city of Athens. He begins his sermon with these words:

*Athenians, I see how extremely religious you are in every way.
For as I went through the city,
and looked carefully at the objects of your worship,
I found among them an altar with the inscription, "To an unknown god."
What therefore you worship as unknown, this I proclaim to you... (Acts 17:22-23)*

In that sermon Paul goes on to tell about God, who made everything, including us, and about Jesus Christ, "whom God raised from the dead."

I thought of this sermon, particularly the opening words ("how extremely religious" the people were) because I believe this is also true about you and me. Like the ancient Athenians, we are "extremely religious." The sheer number of churches, synagogues, mosques, temples, schools and other institutions in our country associated with various religions, the number of believers, the amount of time, talent, and money given to carry out God's ministry and mission in the world – all of this supports the premise of how "extremely religious" we all are.

Consider too the passionate rhetoric we often hear when it comes to religion, particularly when one form of religion bumps up against another form of religion.

We have been overwhelmed these days with news stories about the proposal to build a Muslim community center within a few blocks of Ground Zero in New York City, the site of the World Trade Center, destroyed on 9/11/2001, killing thousands of people (including people of various religions – Christians, Jews, and Muslims). Because the terrorists who carried out this terrible attack called themselves Muslims, some believe putting a Muslim place of worship (called a mosque) this close to Ground Zero would be an affront to the memory of those who were killed there.

All manner of people have raised concerns over this, arguing about the religious freedoms in country, legal concerns, respect and sensitivity matters when it comes to that particular land, viewed by many as "hallowed ground." Here again, note the religious language used around this entire matter, with some of the language, sadly, stoking fear and fire rather than information and spirited discussion.

As for me, I count myself among those who believe the mosque can and should be built on the proposed location in New York City. I read in the news that there is already another mosque within the same radius to Ground Zero, which has been there for over 40 years. I suspect a good part of the opposition to this is based on fear and a lack of understanding of the Muslim faith, a religion followed by over one billion people around the world. I also see similarities between the "Muslims" who perpetrated the 9/11 attacks to the "Christians" who are members of the Klu Klux Klan who perpetrated much violence on African Americans and others in decades past. Both are extremist groups, using the good name of a religion, using "proof-texts" from sacred writings, all to justify their violent desires and methods. And both are on the wrong side of genuine religion and faith.

I wonder... if there was a proposal to build a mosque closer to us here, say along Bardstown Road in Fern Creek, what would the local reaction be? Something to think about.

Pastor Ken Hockenberry

High School & Middle School Events in September

September 5

Louisville Bats Baseball
6:15 p.m.

September 12

RALLY DAY
9am Pancake Breakfast
9am Rally Day Fair
9:30am Sunday School

September 19

HUNGER WALK
Immediately following
worship.

September 26

HOMECOMING Sunday
Dinner immediately
following worship in the
gym.



Beulah Buddies are Walking in September!

The September activity for Beulah Buddies is the Hunger Walk. Immediately following worship, on Sunday, September 19, Beulah Buddies will participate, along with other Beulah youth and adults, in this afternoon event.

If you are a 3rd, 4th or 5th grader you can be a Beulah Buddie. Questions? Talk to Terry Hargrave, Christian Education Director.

Watch for upcoming activities for Beulah Buddies in future bulletins and Beulahs.



College Connection Begins Again!

As summer comes to a close...all too quickly...it is time to get ready for a new school year. And time to start thinking about the College Connection. The College Connection is a Beulah ministry for all college/military aged young people. Members of the congregation 'adopt' a student for the school term and send them an email or card to let them know we are thinking of them and wishing them well.

Some of our college/military youth are leaving home for the first time and a card in the mailbox is a welcome sight. Those who are living at home still are venturing out into the bigger world and need our support.

On Rally Day there will be a display in the lobby with names and addresses of our college youth. Simply take a name and then send a card, email or care package to that student throughout the school year. It is a simple gesture of love and support that keeps the connection between the students and their church family.

If you have any questions about this ministry, feel free to talk with Terry Hargrave or Linda DeSanto. Thank you for your continued support of our college/military young people. Students and parents...make sure that Terry Hargrave has your current school address.

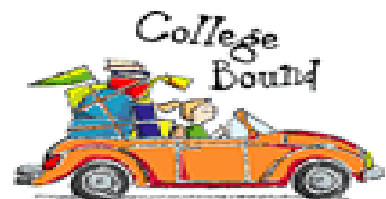

WHAT'S NEW FOR BEULAH SUNDAY SCHOOL IN 2010-2011 "Grow Your Faith Deep and Wide"

September 2010 Theme: One Says, "Thank You!"

Opening (Chapel "secret" room in the sanctuary behind the pulpit area) - Jane Poole

Kids' Club (K-2nd Grade) and Beulah Buddies (3rd-5th Grade)



Date	Group	Workshop/Location	Leadership
September 12	K – 5 th grades	Introduction	Terry Hargrave
		Tour of all spaces	Jane Poole
September 19	K – 5 th grades	Games & Puzzles	Hope Schmidlapp
		Blue Hall Classroom	Lori Witherspoon
September 26	K – 5 th grades	Computers	Brigid and Chris Breetz
		Computer Lab	

Middle and High School Youth led by Laura Mills

The Middle and High School youth will study Revelation, the Psalms & Proverbs Talksheet, Bible-Life-Faith Questions (will discuss money management and service to others) and Just Eating (will discuss hunger here and around the world).



Adult Sunday School Classes for 2010-2011

The Fidelis Class, taught by Nancy Leach, Verna Williams and Claudia Zoll, will read and discuss Great Themes of the Bible, Volume 2, by Sarah S. Henrich. This class meets in the Fireside Room at 9:30 a.m.

The Conversations Class, led by Linda Denny, will read and discuss Have a Little Faith, by Mitch Albom. This class meets in the Memorial Room at 9:30 a.m.

There's a Class for You!



Beulah's Sunday School Teachers for 2010-2011

Nursery
(Birth - 18 months)
Toddlers
(18 months - 2years)
 Carol Nagle
 Nursery

Preschool (2-4 years)
 Tracy Herman
 Room across from the
 nursery.
 "We Believe
 Curriculum"

Grades K - 2
Grades 3 - 5
 Bible story time
 Terry Hargrave
 Jane Poole

Computers
 Chris & Brigid Breetz

Games and Puzzles
 Hope Schmidlapp
 Lori Witherspoon

Drama & Storytelling
 Katie Hockenberry
 Judy Hockenberry

Music & Worship
 Marena Vittorio
 Terry Watson

Art
 Ramona Woodcock
 Susan Ryan

Cooking
 Shelly Leach
 Jennifer Hagan

Audiovisual
 Toby Magruder
 Heather Mohn

Creative Movement
 Jodi Mitchell
 Jane Tackett

Bible Detective
 Jodi Mitchell
 Jane Tackett

Science
 Jim & Terry Watson

Locations for various workshops for children are:
 Downstairs in the main church building, Room 11 (Blue Hall), the Chapel, and the middle room upstairs, Ramsey building.

Teachers will see all children to appropriate workshop locations.

Adult Classes:
Fidelis Class
 Verna Williams, Nancy Leach & Claudia Zoll
 Fireside Room
 Ramsey Building

Conversations Class
 Linda Denny
 Memorial Room
 Ramsey Building



Attention!

August 2010 Statistics	
Worship	
August 1	123
August 8	104
August 15	150
August 22	144
August 29	132

Beulah Fall Worship begins on Sunday, September 5, at 10:40 a.m.

Sunday School will resume on RALLY DAY September 12 at 9:30 a.m.

The Church office will be closed on Labor Day, September 6.

Beulah Deadline September 17, 2010

Hopewell Presbyterian Church Fish Fry September 11 12:00p - 7:00p



Make a Joyful Noise! Music Rehearsals Begin Wednesday, September 1!



The music program ensembles are ready to hit the ground running with our fall and winter music!

Choir practice resumes from 7:00-8:30pm on Wednesday nights, and we are going to have a great time this fall with wonderful music for the choir as well as special guest musicians playing with us!

The **instrumental ensemble** and **handbell choir** will be continuing their every other month schedule from the spring: instrumental ensemble will rehearse from 6:00-7:00pm on Wednesdays in the months of September and November, and the handbell choir will rehearse in October and December.

All three of these groups are open to new members - please come out and give it a try!

If you have any questions, don't hesitate to call Jack or Virginia Copley, co-directors of music.

Choir Open House in the Beulah Music Room Wednesday, September 22, 7:00pm



Have you always wondered what it would be like to sing in the choir, but just couldn't work up your nerve to find out?

Now you can! The choir is holding an open house for anyone who would like to see what it's like to rehearse and sing with the choir on Sunday!

The choir will rehearse the anthem to be sung the following Sunday (Homecoming Sunday) and then have fellowship time after so you can get to know the friendly members of the choir.

No commitment required if you would just like to sing the one Sunday, but hopefully you will see that singing with the choir is a true joy and you'll consider becoming a part of our music ministry!

Christmas in September, Sunday, September 19, 3:30 PM - Beulah Music Room



The choir will be kicking off their Christmas Cantata rehearsals in the usual fashion: with a party and food!!! This is the introductory rehearsal of the cantata "Sing Noel!" If you love to sing but don't have the time to devote to choir every Wednesday, please consider coming to our "Christmas in September" party - after that, we will rehearse the cantata twice a month, and only for 30 minutes to an hour each rehearsal. This is definitely the year to be a part of the cantata! Accompanying the choir will be a string quartet made up of members of the Louisville Orchestra, along with handbells and drums - a rare and wonderful opportunity! Please come and be a part of the fun!

Fall News & Events of Presbyterian Women

Getting to know you!
PW would like to do that. Do come and join one of the circles and enjoy the fellowship they provide.

If you have been thinking of joining a circle, now would be a great time to

do so since we'll be starting the new Horizon Bible Study, *"Journeys Through Revelation: Apocalyptic Hope for Today*, by Barbara Rossing.

Revelation is the book in the Bible that causes

more curiosity, puzzlement, and bemusement than any other book.

Come, let us study, agree, disagree, discuss and try to understand that Revelation is, in the end, a message of hope.

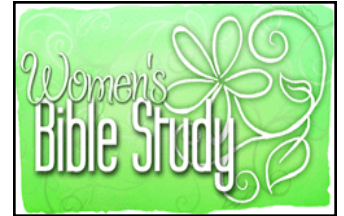

PW Coordinating Team & Circle Meetings For September

The PW Coordinating Team will meet on September 23, at 10:30 a.m. in the library.

September Circle meetings are as follows:

- **Circle Too**
Wednesday, September 1,
Fireside Room, 11:30a.m.

- **Deborah Circle**
Thursday, September 9,
Fireside Room, 9:30 a.m.
- **Esther Circle**
Tuesday, September 14,
Fireside Room, 7:00 p.m.

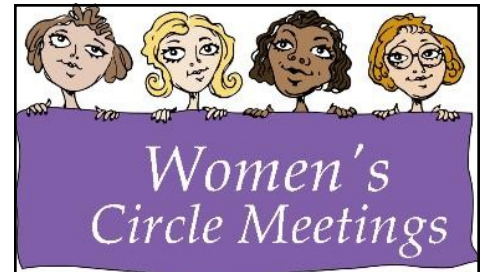

Upcoming PW Events - Mark Your Calendars

Annual
Prayer
Service



Mid-KY PW Annual Prayer Service is Saturday, September

11, at Briargate Presbyterian Church, 2100 Upper Hunters Trace, at 10:30 a.m.

Mid-Kentucky Fall Gathering at Trinity Presbyterian Church, 10200 Shelbyville Road, Saturday, October 16, 9a.m. - 12 noon
Emily Seeger will speak.

Thank Offering & Shoebox Collection
Sunday, November 14

Cookie Walk
Sunday, December 12



Beulah Church & Preschool's Craft Bazaar & Yard Sale - Saturday, October 30 - 8:00a - 1:00p

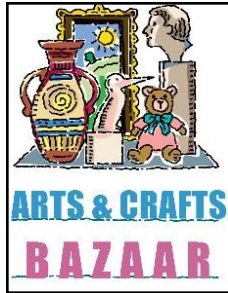

OCTOBER 30
8:00 A.M.
until
1:00 P.M.

What can you do?

You can rent a space for \$20 to sell your crafts OR your yard sale treasures. If you have yard sale items and you don't want to sell them yourself, you can donate your treasures and the profits will be divided between the church and preschool. Your donations are tax deductible.

What kind of things should you donate?

Just about anything! Clothes (clean and in good condition), utensils, furniture, tools, toys, books, antiques, collectibles, hardware, etc.

Your junk may be someone else's treasure!

Where do I bring my donations?

To the Ramsey Building BEGINNING SUNDAY, October 24, after church through Friday, October 29. Weekday delivery will be accepted from 9:00 a.m. to 1:00 p.m. (Come to the Preschool Office entrance and ring door bell.)

It would be very helpful if you would price your items and help put them out for display. But, even if you can't help with displaying items, we still need your donations!

The more items we receive the more successful we will be.

To reserve your spot, to arrange for donating items, or to volunteer to help in some way with the craft bazaar & yard sale, please call Carla Wood, 239-3231.

Help is needed anytime on Friday for set up and early on Saturday from 7:00 a.m. till 1:00p.m.

Please help if you are able.

BEULAH'S ART GROUP RESUMES

"Beulah's art group will resume on the second Thursday of each month, beginning September 9, from 6:30 to 8:30, in the Fireside Room, Ramsey building.

This group is for anyone who likes to be creative with scissors, glue, paint, stamps and other art media.

A new technique will be taught each month that can be used for altered books, art journals, scrapbooks, cards, or larger art pieces.

The art group is for youth and adults and meets on the 2nd Thursday of the month.

So, come and explore your creative side (and we all have a creative side).

If you have any questions about this group, feel free to contact Linda DeSanto, 491-1673.

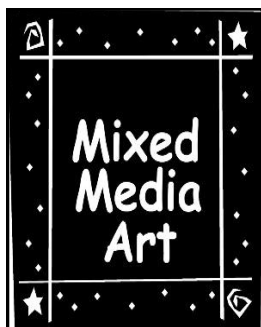

Check Out the Library!

Young children (and you) will love the delightful picture books by Kathleen Borstrom. From [Are Angels Real](#), [Green Plagues and Lamb](#), [What is God Like](#) to [Why is There a Cross](#) (and nine more) you have a special opportunity to share your faith with the very young.

Familiar with Robert Fulghum's [All I Need to Know I Learned in Kindergarten](#)? Explore his additional inspirational works: [From Beginning to End](#) and [Maybe \(Maybe Not\)](#).

Perhaps you might like to try [Eat, Pray, Love](#) by Elizabeth Gilbert and compare it with the newly released movie version.

In the mood for legal mystery? Now's your chance to delve into John Grisham, if you haven't already. We have [The Appeal](#), [Associate](#), [Brethren](#), [Innocent Man](#) and [Summons](#) just waiting for your interest.



Meet Our New Seminarian, Marena Vittorio

Hello, I'm Marena Vittorio, your seminary intern for the 2010-2011 academic year. I'm really excited to grow into my pastoral identity at Beulah and to get to know you better throughout the year. Here are some tidbits about me.

Throughout childhood, I lived in all the "I" states except for Idaho. My mother and I moved frequently as she was an ordained Disciples of Christ minister.

When I entered undergraduate studies, she was ordained in the Presbyterian Church(USA) and now serves parish ministry in Rushville, Indiana.

My father died when I was an infant. I am blessed to have a wonderful step-father named Dennis. He was an engineer for many years but now has his own business as a woodworker. Dena and Dennis care for the farm that has been part of our family for nearly 125 years!

As far as interests are concerned, I love celebrating holidays, particularly Halloween, reading books, going for walks, studying different cultures, and traveling. So...before any of you head out for a

vacation this year, check your luggage to make sure I'm not hiding in it!

At a young age, I threw myself into music studies. I love expressing myself through the diverse realm of music. I also enjoy the sense of community that arises from rehearsing in choral or instrumental ensembles and then offering the music to God in worship.

I received my undergraduate at DePauw University in Piano Performance and Anthropology and then received my Masters in Sacred Music at Emory University specializing in Organ Performance.

While music will always be a huge passion of mine, I feel called to explore and develop the ministry of Word and Sacrament. I look forward to being involved in liturgy and word, education, and pastoral care with Pastor Ken Hockenberry, Terry Hargrave and each of you.



James O. Leach Hunger Awareness Dinner

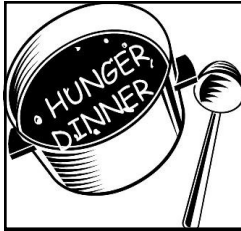

September 18
7:00 p.m.

The 12th Annual James O. Leach Hunger Awareness Dinner, sponsored by Fern Creek/Highview United Ministries, will be held at Fern Creek United Methodist Church, 6727 Bardstown Road on **Saturday, September 18, @ 7:00 p.m.**

Proceeds from the dinner benefit the Community Hunger Walk and FC/HUM's Individual & Family Assistance Center.

Each individual/family is asked to bring a jar of peanut butter for IFAC.

Tickets can be purchased at the door. The cost is \$6 for adults and \$3 for children.

Everyone is invited to attend! Hope you can make it.

Community Hunger Walk/Run 2010 Together, We'll Put Hunger On The Run!



This is the 32nd Anniversary of the Hunger Walk, a 5K Walk & Run.

This event will take place on **Sunday, September 19**, at Waterfront Park's Festival Plaza. All Beulah members and friends are encouraged to participate.

Beulah folks will leave church immediately following worship.

If you can't participate please consider making a monetary donation.

- Hunger Walk festival 12:30-4:30pm
- Pre-registration packet pick up and event day registration 12:30-2pm
- Walk/Run starts at 2:15pm
- 5K course crosses the Second Street

Bridge and returns to Festival Plaza

- Awards ceremony at approximately 3:30pm
- Door prizes

Mission & Outreach Commission asks for Volunteers!



Volunteer Opportunity! The Mission Outreach Commission is in need of volunteers to collect the "Who's Who in the Pew" sheets after church. Once they have been collected, the volunteer makes note of any visitors in an already existing system. The time commitment can be as little as once-a-month for a few minutes after worship. This is a wonderful opportunity for those who are looking for a simple way to make a difference in the mission efforts of our church. Please contact Jodi Yates by email at tjyates@insightbb.com if you would like to serve.

English Language Learners

Beulah will offer English Language Learner's Program (ELL) to the community from September 13th to November 17th.

Classes will be held every Monday and Wednesday from 6:00-8:00pm.

Teachers are needed for class instruction and volunteers are needed for child care and food preparation.

If you are willing to help out, please sign the volunteer sheet posted in the church lobby or

contact Heeja Han (239-3231) or Laura Mills.

Please spread the word to your family and friends.



Flu Shots to be Given at Beulah!

On Sunday, October 10, immediately following worship, flue shots will be given by Walgreens in the church library. The shot will cost \$29.99.

If you have Medicare all you will have to do is fill

out the appropriate information that morning.

If you plan to use another type of insurance, you will need to go to the Walgreen store across the street,

ahead of time to fill out the appropriate papers so your insurance can be pre-approved.



The Pumpkins Are Coming - Saturday, October 16

Beulah Church is now very famous in the Fern Creek area for her "pumpkin patch!"

This year, like years in the past, your help will be needed to unload and "plant" the patch.

The pumpkin truck will arrive on Saturday, October 16, at 8:30 a.m. and many volunteers are needed, rain or shine, to "plant" this year's crop.

This year there will be a pancake breakfast for all those helping to plant the patch.

There will be gourds and Indian corn for sale as well as pumpkins.

The patch will be open from October 16 through October 31 from 11:00 a.m. until dark.

This is a major fundraiser for the youth and all monies received will help with their summer mission trips and conferences.

Sign up in the church lobby or talk to Terry Hargrave if you can work in the patch.



Third Annual Autumn Under the Cedars Dinner to benefit Cedar Ridge Camp



October 2

All Beulah members and friends are invited to the third annual Autumn Under the Cedars Dinner to support the mission of Cedar Ridge Camp.

Mark your calendar for Saturday, October 2, at 6:00 p.m. for an evening of hors d'oeuvres, a three-course dinner, live music, a raffle and an optional tour of the camp.

Individuals - \$75; table of 8 - \$525. For more information or to RSVP, please contact Cedar Ridge Camp at 267-5848.

Cedar Ridge Camp provides a unique ministry within our presbytery. Just 30 minutes from downtown Louisville, this beautiful 64-acre camp provides children, youth and adults with an

opportunity to discover the beauty and mystery of God's creation.

As part of their ministry, Cedar Ridge is committed to serving all of our community and we are continually developing programs to reach and serve the neediest among us. Last year the Camp served 20,000 children and adults.

Financial Report - January thru July 2010



Income

Pledge & Regular Giving	\$ 190,486
Debt Reduction	1,737
Other	<u>20,951</u>
Total Income	\$ 213,174

Expenses

Mission & Outreach	\$ 23,837
Christian Education	12,236
Fellowship/Membership	1,667
Stewardship	52,292
Personnel	<u>138,443</u>
Total Expenses	\$228,475

Cash @ 7/31/2010

Operating	\$ (1,561)
Designated	<u>3,770</u>
Total	\$ 2,209

Outstanding Debt @ 7/31/2010

Loans	\$ 24,170
Credit Card Charges	2,227

Beulah Work Day - Saturday, September 18

Join other members and friends for Beulah's fall work day on Saturday, September 18, from 9:00 a.m. until 12:00 noon.

Bring your own tools for outside work.

Please consider helping to "spruce up" the church grounds for Homecoming as well as to prepare the flower beds for fall and winter.

The entire family can participate on WORK DAY.

The Stewardship Commission thanks all of you in advance for helping to keep Beulah Church beautiful!



Beulah's Family Album

Address Changes

Bob & Janet Azinger
187 Brookside Drive
40243-1205 245-7803



Illness & Hospitalization

Emma Kennedy, Kelsey Rock, Joe Scott, Edie McCaulley, Helen Crawford, Virginia Gregory, Lucille Mattingly, Dorothy Howell, John Smith, Keith Lyons, Bob Tackett, Robert C. Tackett, Bill & Bette Banks, Rose Lukat, H.T Kennedy, Mayanna Bennett, Bettte Dreher and Mildred Phillips.

Edie and David

McCaulley upon the birth of grandson, Jensen David Hutchison, born June 30. The proud parents are Stacy and Becky (McCaulley) Hutchinson.



Congratulations to

Bill and Jane Flanigan who celebrated their 34th Wedding Anniversary on August 28.

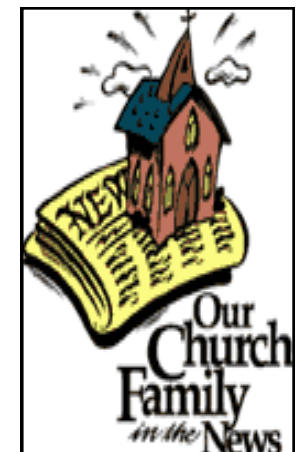

Charlie and Jean Stirsm

an upon the birth of a great grandson, Sean Paul Whitmer, born August 20. The proud parents are Angie and Paul Whitmer.



Congratulations to

Donna Hagerthey who won "Best in Show" in china painting at the Kentucky State Fair.

Barbie and Steve

Turner, upon the birth of granddaughter, Natali Elizabeth Cummins, born August 27. The proud parents are Staci and Jonathan Cummins.

Congratulations also

to Sidney Hagerthey who won a first place (blue) ribbon in the children's division, china painting at the Kentucky State Fair!

WOW!

Beulah Members & Friends Say Thanks



Dear Beulah Church,
We are so appreciative of you for allowing us to meet in the Ramsey Building for our china painting seminar. We enjoyed it so much.
Many thanks,
The China Painters

Dear Beulah Family,
Thank you for the beautiful plant you sent upon Jack's death. Many thanks for all of your support during the past year.
Cheryl Hill

Happy September Birthday!



- | | | | | | |
|----|-----------------|----|--------------------|----|------------------|
| 5 | Suzi Crisco | 13 | Melanie Magruder | 24 | Jane Tackett |
| | Nathan Ford | 14 | Stephanie Hargrave | 27 | Bobbie Lombard |
| | John Willen IV | 16 | Brad Learn | | Mildred Phillips |
| 6 | Ethel Wilkerson | 17 | Pat Metzger | | Bill Rush |
| 7 | Heather Mohn | 18 | Kristin Mischel | 28 | Stan Bradley |
| 8 | Madison Dunham | | Bill Newman Sr. | | Rob Flaherty |
| 9 | Martha Burn | 19 | Dorothy Rush | | Mark Leach |
| | Kim Rock | 20 | Tom Stokes | | Matt Leach |
| | John Smith | 21 | John Greene Sr. | | Nita Stephan |
| 11 | Bill Anderson | 23 | John Rader | 29 | Meta Edwards |
| 12 | Max Bennett | 24 | Chad Hagan | 30 | Brianna Vitt |

Look Who's Celebrating in October!

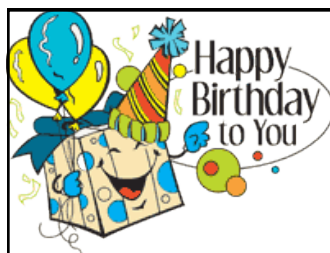

- | | | | | | |
|---|------------------|----|---------------------|----|------------------|
| 1 | Bob LeBlond | 10 | Brenda Duke | 21 | A.J. Boston |
| 2 | Sidney Hagerthey | | Sherri Schuenemeyer | | Larryetta Ellis |
| 3 | Don Herman | 11 | Brent Dellacoletta | 23 | Scott King |
| | John Ramsey | | Cindy Magruder | 24 | Allyson Meade |
| 4 | Samantha Adams | | Jack Rader | 25 | Kelsey Rock |
| 5 | Cindy Bunnell | 13 | Tim Troendly | 26 | Beverly McCauley |
| | Nora Schroeder | 14 | Nova Stonefield | 27 | Janet Ogle |
| 7 | Tyler Adams | 15 | Jackie Searcy | | Claudia Zoll |
| | Carrol Treese | 16 | Linda Stivers | 28 | Declan Flaherty |
| | Lori Witherspoon | 17 | Bob Anderson | 29 | Harrison Fox |
| 8 | Beau Bradley | 18 | Micki Rader | 30 | Barbara Greene |
| 9 | Joe Arnett | 20 | Mitchell Gardner | 31 | Blake Ryan |
| | | | Karen Johnson | | Joel Tackett |

Life Line Screening

Beulah Presbyterian Church is hosting a community-wide health and wellness screening. Life Line Screening will be at Beulah Presbyterian Church on Monday, October 4th in the Fireside Room to offer the following vascular disease screening tests:

Stroke Screening / Carotid Artery -ultrasound
Abdominal Aortic Aneurysm Screening - ultrasound
Peripheral Arterial Disease Screening (i.e. PAD / hardening of the arteries) - ultrasound
New Atrial Fibrillation Test (tests for the most common type of irregular heartbeat)
Osteoporosis Screening

The tests are painless and non-invasive. No X-rays, No needles, No disrobing! The cost for all four, life-saving vascular tests is \$149 and will include a FREE Osteoporosis test.

People who should consider these tests are those with the following risk factors:

Family history of stroke or heart disease or aneurysm

High blood pressure

High cholesterol

Diabetes

History of smoking

Irregular Heart Beat

Problems can be detected early before they become life threatening. If you think you are at risk of vascular disease, Life Line Screening would be happy to answer any questions about the tests or help you make an appointment.

Call 502-894-9228 or 800-679-5609 (mention code CHM01001). Screening events will often completely fill up, so appointments for the screening are required.

Beulah Presbyterian Church is dedicated to its members and the community. Your health and well-being are important to us.

Beulah Presbyterian Church

In addition, a 5-year Disease Risk Assessment will be offered. This shows your individual percentage risk for heart disease, stroke, diabetes, heart failure, COPD and lung cancer, as well as your cholesterol and blood sugar levels. Your personalized report indicates your risk factors and what changes you can make for the greatest improvement. This valuable assessment is \$70.

September 2010

Monthly Planner

Sunday	Monday	Tuesday	Wednesday	Thursday	Friday	Saturday																																																								
<table border="1" style="margin: auto;"> <tr><td colspan="7" style="text-align: center;">August</td></tr> <tr><td style="text-align: center;">S</td><td style="text-align: center;">M</td><td style="text-align: center;">T</td><td style="text-align: center;">W</td><td style="text-align: center;">T</td><td style="text-align: center;">F</td><td style="text-align: center;">S</td></tr> <tr><td style="text-align: center;">1</td><td style="text-align: center;">2</td><td style="text-align: center;">3</td><td style="text-align: center;">4</td><td style="text-align: center;">5</td><td style="text-align: center;">6</td><td style="text-align: center;">7</td></tr> <tr><td style="text-align: center;">8</td><td style="text-align: center;">9</td><td style="text-align: center;">10</td><td style="text-align: center;">11</td><td style="text-align: center;">12</td><td style="text-align: center;">13</td><td style="text-align: center;">14</td></tr> <tr><td style="text-align: center;">15</td><td style="text-align: center;">16</td><td style="text-align: center;">17</td><td style="text-align: center;">18</td><td style="text-align: center;">19</td><td style="text-align: center;">20</td><td style="text-align: center;">21</td></tr> <tr><td style="text-align: center;">22</td><td style="text-align: center;">23</td><td style="text-align: center;">24</td><td style="text-align: center;">25</td><td style="text-align: center;">26</td><td style="text-align: center;">27</td><td style="text-align: center;">28</td></tr> <tr><td style="text-align: center;">29</td><td style="text-align: center;">30</td><td style="text-align: center;">31</td><td></td><td></td><td></td><td></td></tr> </table>			August							S	M	T	W	T	F	S	1	2	3	4	5	6	7	8	9	10	11	12	13	14	15	16	17	18	19	20	21	22	23	24	25	26	27	28	29	30	31					1 11:30 AM Circle Too 6:00 PM Instrumental Ptc. 7:00 PM Choir	2	3	4							
August																																																														
S	M	T	W	T	F	S																																																								
1	2	3	4	5	6	7																																																								
8	9	10	11	12	13	14																																																								
15	16	17	18	19	20	21																																																								
22	23	24	25	26	27	28																																																								
29	30	31																																																												
5 9:30 AM Bible Study 10:40 AM Worship 6:15 PM Bats Game	6 LABOR DAY Office Closed	7 7:00 PM Preschool Orientation	8 9:00 AM Bridge 1:30 PM Book Club 6:00 PM Instrumental Ptc. 7:00 PM Choir 7:00 PM Technology Mtg.	9 9:00 AM Preschool Begins 9:30 AM Deborah Circle 6:30 PM Art Group	10	11 10:00 AM Set Up for Rally Day 10:00 AM SS Teacher Mtg. 10:30 AM Mid KY PW Prayer Service/Briargate																																																								
12 9:00 AM Pancake P'Est 9:30 AM SS 10:40 AM Worship 12:00 PM Lunch & Council 12:30 PM Commissions 2:00 PM Personnel RALLY DAY	13 6:00 PM ELL Classes	14 7:00 PM Esther Circle	15 9:00 AM Bridge 6:00 PM ELL Classes 6:00 PM Instrumental Ptc. 7:00 PM Choir	16 7:00 PM Generosity Mtg.	17 6:30 PM Cub Scouts	18 9:00 AM Work Day 10:00 AM Presbytery Mtg. Cedar Ridge 7:00 PM Hunger Dinner																																																								
19 9:30 AM SS 10:40 AM Worship Hunger Walk	20 6:00 PM ELL Classes	21 7:00 PM Session	22 9:00 AM Bridge 1:30 PM Book Club 6:00 PM ELL Classes 6:00 PM Instrumental Ptc. 7:00 PM Choir	23 10:30 AM PW CT Meeting	24	25 10:00 AM Set Up for Homecoming																																																								
26 9:30 AM SS 10:40 AM Worship 12:00 PM HOME-COMING DINNER	27 6:00 PM ELL Classes	28	29 9:00 AM Bridge 6:00 PM ELL Classes 6:00 PM Instrumental Ptc. 7:00 PM Choir	30	<table border="1" style="margin: auto;"> <tr><td colspan="7" style="text-align: center;">October</td></tr> <tr><td style="text-align: center;">S</td><td style="text-align: center;">M</td><td style="text-align: center;">T</td><td style="text-align: center;">W</td><td style="text-align: center;">T</td><td style="text-align: center;">F</td><td style="text-align: center;">S</td></tr> <tr><td></td><td></td><td></td><td></td><td></td><td style="text-align: center;">1</td><td style="text-align: center;">2</td></tr> <tr><td style="text-align: center;">3</td><td style="text-align: center;">4</td><td style="text-align: center;">5</td><td style="text-align: center;">6</td><td style="text-align: center;">7</td><td style="text-align: center;">8</td><td style="text-align: center;">9</td></tr> <tr><td style="text-align: center;">10</td><td style="text-align: center;">11</td><td style="text-align: center;">12</td><td style="text-align: center;">13</td><td style="text-align: center;">14</td><td style="text-align: center;">15</td><td style="text-align: center;">16</td></tr> <tr><td style="text-align: center;">17</td><td style="text-align: center;">18</td><td style="text-align: center;">19</td><td style="text-align: center;">20</td><td style="text-align: center;">21</td><td style="text-align: center;">22</td><td style="text-align: center;">23</td></tr> <tr><td style="text-align: center;">24</td><td style="text-align: center;">25</td><td style="text-align: center;">26</td><td style="text-align: center;">27</td><td style="text-align: center;">28</td><td style="text-align: center;">29</td><td style="text-align: center;">30</td></tr> <tr><td style="text-align: center;">31</td><td></td><td></td><td></td><td></td><td></td><td></td></tr> </table>		October							S	M	T	W	T	F	S						1	2	3	4	5	6	7	8	9	10	11	12	13	14	15	16	17	18	19	20	21	22	23	24	25	26	27	28	29	30	31						
October																																																														
S	M	T	W	T	F	S																																																								
					1	2																																																								
3	4	5	6	7	8	9																																																								
10	11	12	13	14	15	16																																																								
17	18	19	20	21	22	23																																																								
24	25	26	27	28	29	30																																																								
31																																																														

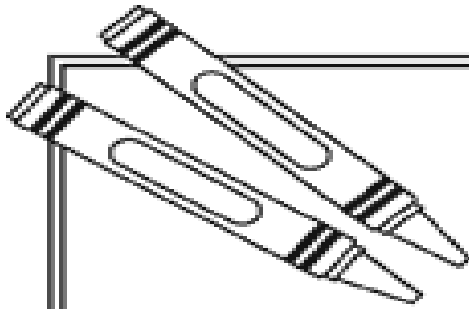

Just for KIDS

GOD'S INSTRUCTION

The Bible is a guide for how we should live. In Sunday school and at home, we learn how God loves and saves us. Solve this puzzle to find Proverbs 4:13 (NIV), which tells about the importance of God's Word.

First, write the word that means the opposite of the one given. Then write the correct letters on the number-coded lines below.

young 1 2 3 death 2 6 7 8 cold 4 1 5 come 9 1
 sweet 10 1 11 12 can't 13 14 15 no 16 8 10 later 15 1 17

H
 4 1 2 3 1 15 5 1
 6 15 10 5 12 11 13 5 6 1 15 ' 3 1
 15 1 5 2 8 5 6 5 9 1 ;
 9 11 14 12 3 6 5 17 8 2 2 ' 7 1 12
 6 5 6 10 16 1 11 12 2 6 7 8 "



Answers: old, life, hot, go, sour, can, yes, now
 "Hold on to instruction, do not let it go; guard it well, for it is your life."
 (Proverbs 4:13, NIV)